

TriaAir fordelerboks

Ø160 nippel – 7 muffler Ø75 L1300 - venstre

Varenr. MC75B07160-3

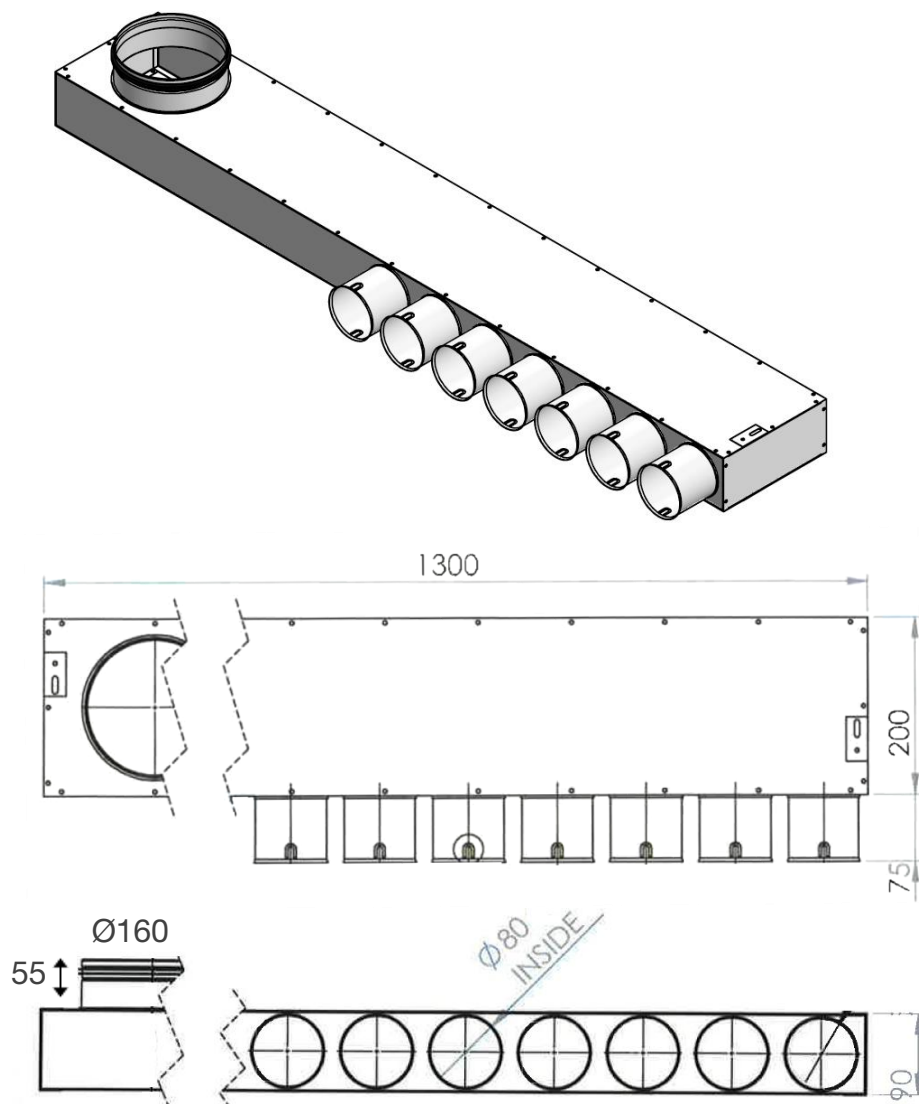

Flowdiagram

MC75B07160-3	
Flow Rate [m ³ /h]	Resistance [Pa]
50	1,1
80	1,6
120	2,1
180	4,1

