

TriaAir fordelerboks

Vinkel Ø100 / H125 mm - 1 muffe Ø75

Varenr. MC75V01100-3

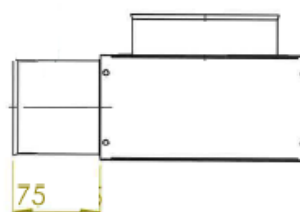
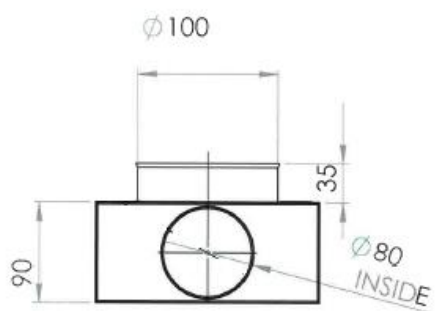
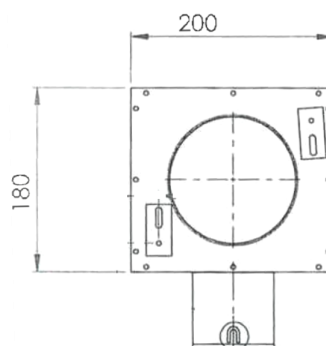

Flowdiagram

MC75V01100-3	
Flow Rate [m ³ /h]	Resistance [Pa]
10	1,2
15	1,9
20	2,4
30	4,2

