

TrioAir[®]

Ventilationsanlæg med
høj varmegenvinding og fugtstyring

Tekniske data

BRHR-325 V - 325/400 m³ - Gulv-/lofts-/vægmodel



Overholder
2020 kravene

5 års garanti
Iflg. AB18

A⁺

Manuel styring A



Manuelt display



Digitalt display



App

Indtag højre side

Varenr.: TWHEAT325 - DIGITAL
Varenr.: TWHEATH325 - MANUEL
Varenr.: TWHEATK325 - APP

Indtag venstre side

Varenr.: TWHEATA325 - DIGITAL
Varenr.: TWHEATHA325 - MANUEL
Varenr.: TWHEATKA325 - APP

Farve: RAL 9003 glans 30 (hvid)

Tekniske data

BRHR-325 V - 325/400 m³

Flowdiagram

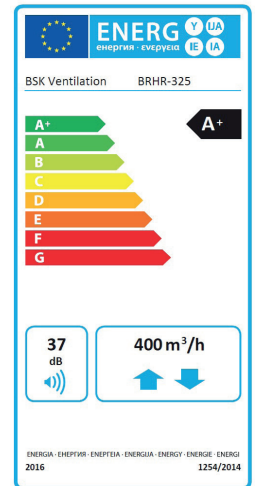
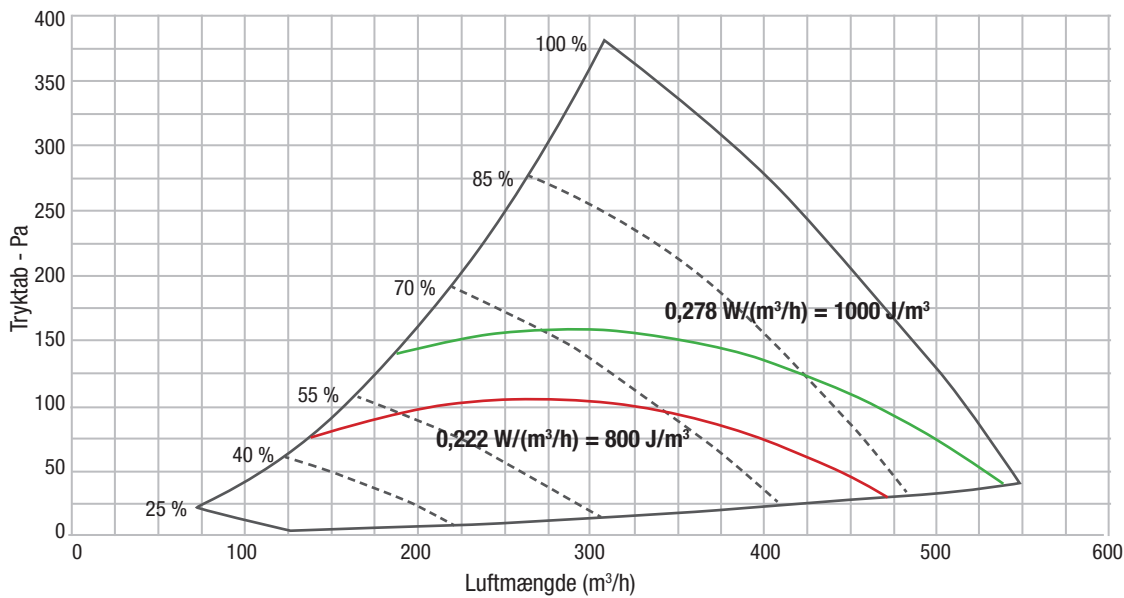

Manuel styring A

Temperaturvirkningsgrad

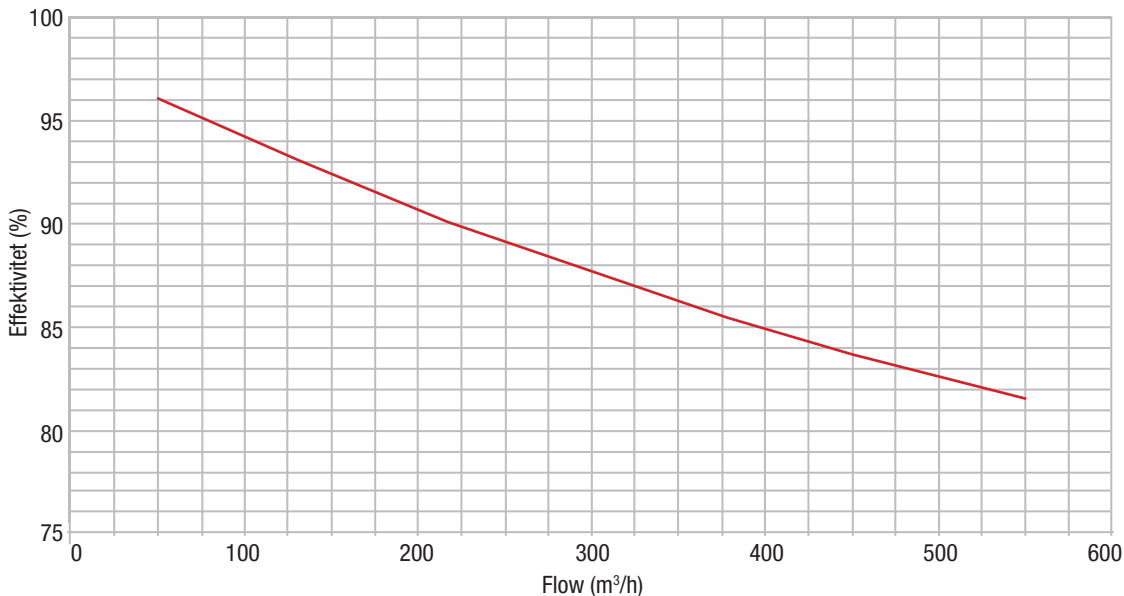

Lyddata (L_{wa})

Tryktab	Støjniveau	Lydeffektivniveau dB (A)									
		Frekvens Hz	63	125	250	500	1000	2000	4000	8000	Gennemsnit
100 Pa	Indblæsning	30	55	60	61	63	60	52	31	51,5	43,7
	Afkast	25	43	50	46	42	37	29	15	35,9	
75 Pa	Indblæsning	23	41	44	45	47	38	29	21	36,0	31,2
	Afkast	18	30	35	33	30	25	25	15	26,375	

Tekniske data

BRHR-325 V - 325/400 m³



Ecodesign

Ventilationsanlæg til boliger iht. EU 1254/2014

Produkt	BRHR 325V	
Producent/varemærke	BSK	
Produkt model	325V manual controller	325V digital controller
Specifikt energiforbrug *SEC (klasse)	A	A+
Specifikt energiforbrug *SEC (gennemsnit)	-39.39 kWh/(m ² .a)	-42.40 kWh/(m ² .a)
Specifikt energiforbrug SEC (kold)	-76.64 kWh/(m ² .a)	-80.64 kWh/(m ² .a)
Specifikt energiforbrug SEC (varm)	-15.42 kWh/(m ² .a)	-17.86 kWh/(m ² .a)
Produkttype	Ventilationsaggregat til boliger/tovejs	
Type drev (flertrinsdrev el. trinløs regulering(VSD))	Trinløs regulering (VSD)	
Type varmegenvindingssystem	Recuperativ	
Temperaturvirkningsgrad af varmegenvinding	85 %	
Maksimal volumenstrøm	515 m ³ /h	
Maksimal elektrisk effekt	170 W	
Lydeffektniveau (Lwa)	37 dB(A)	
Referencevolumenstrøm	0.108 m ³ /s	
Referencetrykforskel	50 Pa	
SEL *(SPI)	0.19 W/(m ³ /h)	
Kontroltype	Central Demand Control	Local Demand Control
Reguleringsfaktor	0.65	0.85
Intern/ekstern lækage	< 2%	
Casing leakage class	L1	
Visuelle filteralarmer	JA (Se i manualen)	
Brugermanual, webadresse	www.termicplus.dk	
Årligt elektricitetsforbrug *AEC (gennemsnit)	2.34 kWh	1.56 kWh
Årlig varmebesparelse *AHS (gennemsnit)	44.57 kWh	45.61 kWh
Årlig varmebesparelse AHS (kold)	87.18 kWh	89.23 kWh
Årlig varmebesparelse AHS (varm)	20.15 kWh	20.62 kWh
Demontage	www.termicplus.dk	

*AEC: Annual Consumption, *AHS: Annual Heat Savings,
*SEC: Specific Energy Consumption, *SPI: Specific Power Input



Tekniske data

BRHR-325 V - 325/400 m³

Tegning - Indtag højre side

Alle mål er i mm

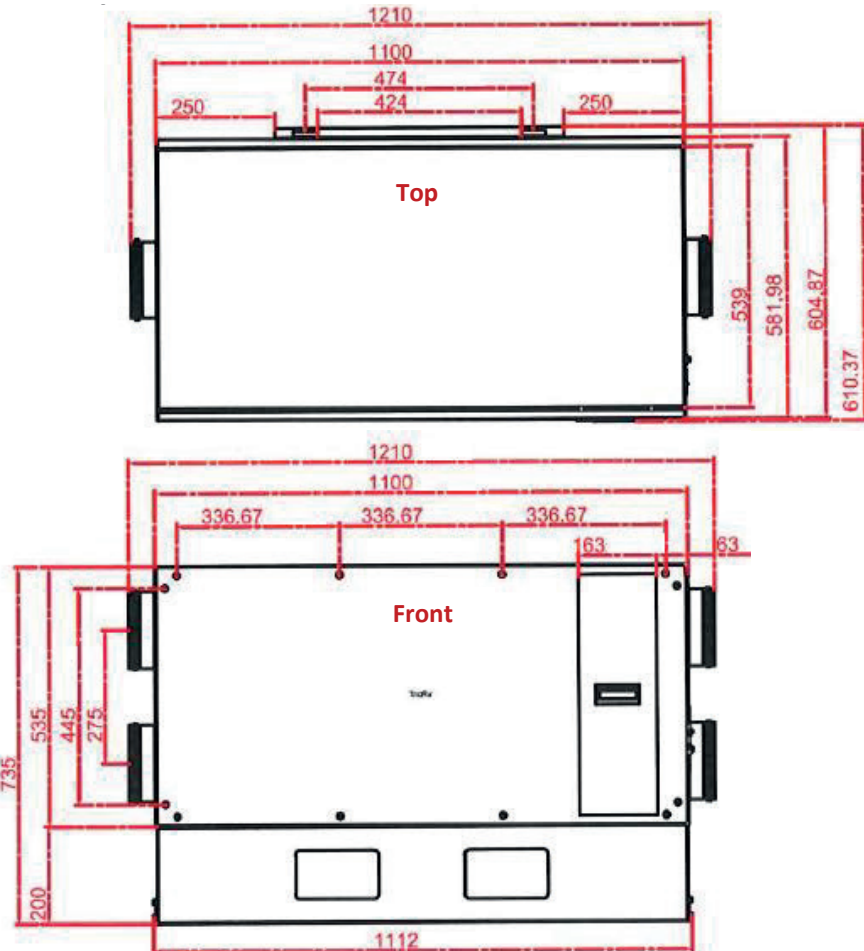

Tilslutninger

- 1 **INDTAG** (udefra og ind i varmeveksler)
- 2 **INDBLÆSNING** (fra varmeveksler og ind i bolig)
- 3 **UDSUGNING** (fra bolig og ind i varmeveksler)
- 4 **AFKAST** (fra varmeveksler til udenfor)

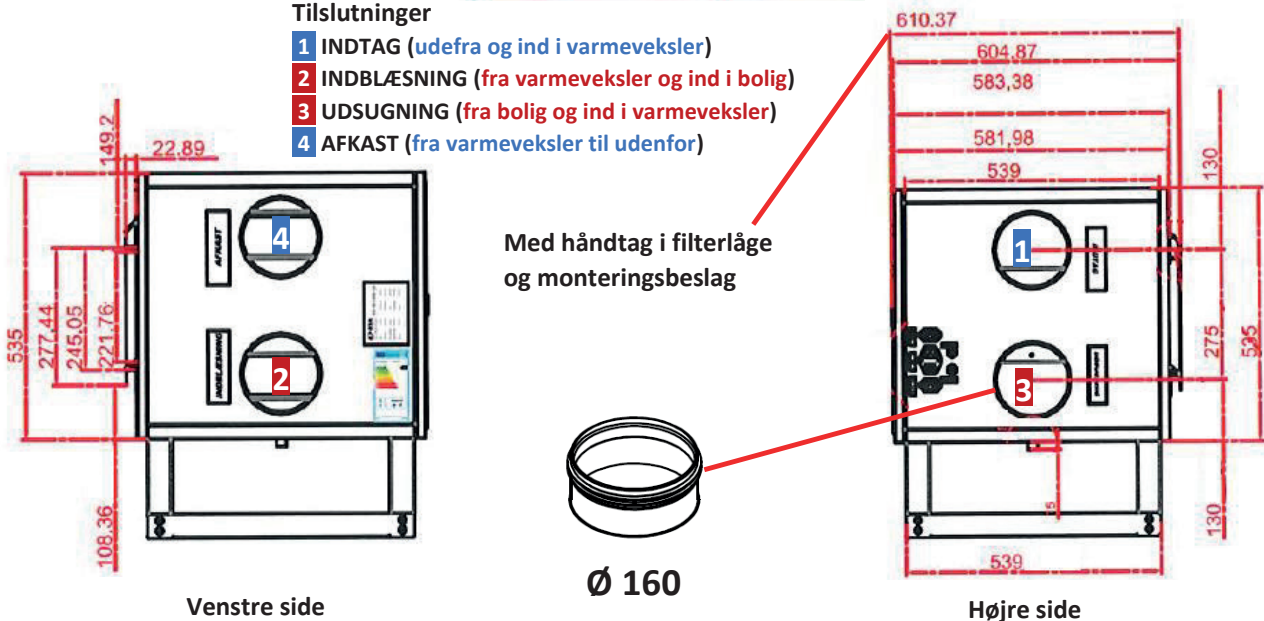

Tekniske data

BRHR-325 V - 325/400 m³

Tegning - Indtag venstre side

Alle mål er i mm

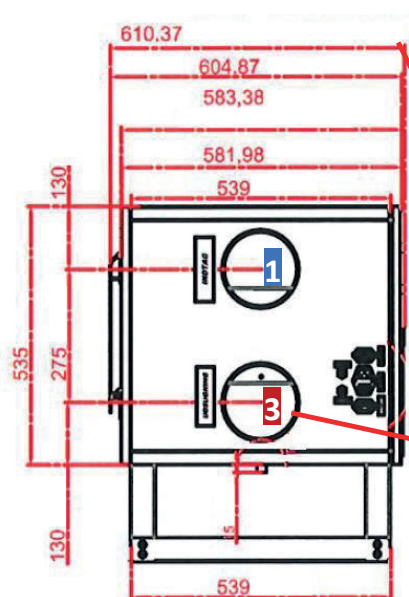
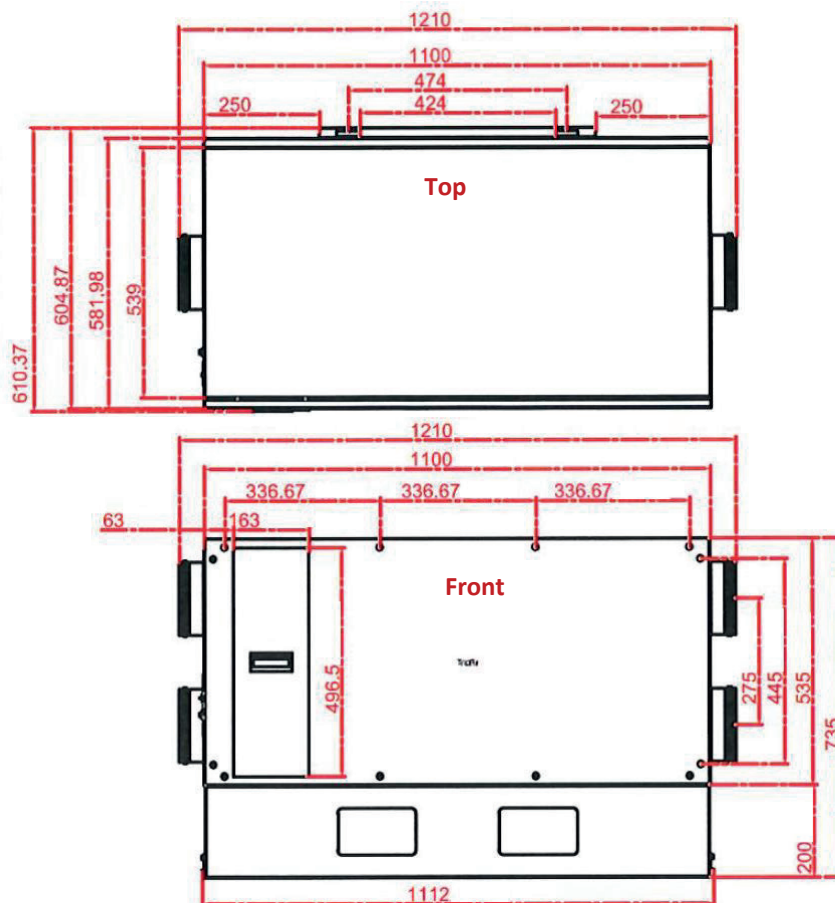

Venstre side

Tilslutninger

- 1 **INDTAG** (udefra og ind i varmeveksler)
- 2 **INDBLÆSNING** (fra varmeveksler og ind i bolig)
- 3 **UDSUGNING** (fra bolig og ind i varmeveksler)
- 4 **AFKAST** (fra varmeveksler til udenfor)

Med håndtag i filterlåde og monteringsbeslag



Ø 160

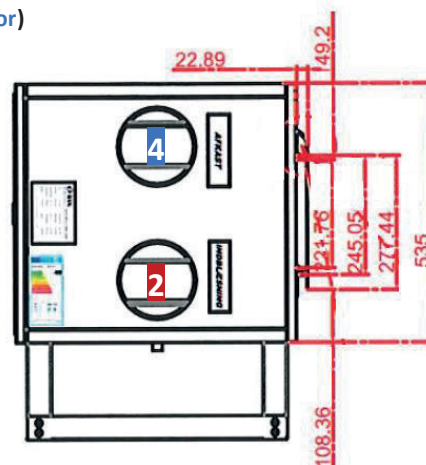

Højre side

Tekniske data

BRHR-325 V - 325/400 m³

CE Certifikat

LGAI Technological Center, S.A. (APPLUS)
 Campus UAB - Ronda de la Font del Carme s/n
 08193 Bellaterra (Barcelona)
 T +34 93 567 20 00
 F +34 93 567 20 01
 www.applus.com

Applus⁺

CERTIFICATE

No. **18/32300200 M1**

CERTIFICATE OF CONFORMITY

LGAI-Technological Center, S.A. CERTIFIES that the documentation included in the Construction Technical file for the compliance of EC marking of:

ISI GERİ KAZANIM CİHAZI / HEAT RECOVERY DEVICE

Models: 1. BRHR-100 V 2. BRHR-150 V 3. BRHR-180 V 4. BRHR-325 V 5. BRHR-400 V 6. BRHR-500 V 7. BRHR-750 V 8. BRHR-1000 V 9. BRHR-1500 V 10. BRHR-2000 V 11. BRHR-2500 V 12. BRHR-3000 V 13. BRHR-3500 V 14. BRHR-4000 V 15. BRHR-4500 V 16. BRHR-5000 V 17. BRHR 100 S 18. BRHR 150 S 19. BRHR 180 S 20. BRHR 325 S 21. BRHR 400 S 22. BRHR-500 S 23. BRHR-750 S 24. BRHR-1000 S 25. BRHR-1500 S 26. BRHR-2000 S 27. BRHR-2500 S 28. BRHR-3000 S 29. BRHR-3500 S 30. BRHR-4000 S 31. BRHR-4500 S 32. BRHR-5000 S 33. BRHR-100 H 34. BRHR-150 H 35. BRHR-180 H 36. BRHR-325 H 37. BRHR-400 H 38. BRHR-500 H 39. BRHR-750 H 40. BRHR-1000 H 41. BRHR -1500 H 42. BRHR-2000 H 43. BRHR-2500 H 44. BRHR-3000 H 45. BRHR-3500 H 46. BRHR-4000 H 47. BRHR-4500 H 48. BRHR-5000 H 49. BRHR-150 SLIM 50. VENTI 100 51. VENTI 150 52. VENTI 200 53. VENTI 300 54. VENTI 400 55. VENTI 500 56. BRHR 220 S 57. BRHR 220 V 58. BRHR 220 H 59. BRHR PLUS 500 S 60. BRHR PLUS 500 V 61. BRHR PLUS 500 H 62. BRHR PLUS 1000 S 63. BRHR PLUS 1000 V 64. BRHR PLUS 1000 H 65. BRHR PLUS 1500 S 66. BRHR PLUS 1500 V 67. BRHR PLUS 1500 H 68. BRHR PLUS 2000 S 69. BRHR PLUS 2000 V 70. BRHR PLUS 2000 H 71. BRHR PLUS 2500 S 72. BRHR PLUS 2500 V 73. BRHR PLUS 2500 H 74. BRHR PLUS 3000 S 75. BRHR PLUS 3000 V 76. BRHR PLUS 3000 H 77. BRHR PLUS 4000 S 78. BRHR PLUS 4000 V 79. BRHR PLUS 4000 H

Manufactured and delivered to market by:

BSK HAVALANDIRMA EKİPMANLARI A. Ş
 MİMAR SİNAN MAH. BASRA CAD. NO: 59 SULTANBEYLİ/İSTANBUL

Is in compliance with Machinery Directive (2006/42/EC), as described in:

Evaluation report No.: 18/32300199_M1

This certificate substitute the certificate number: 18/32300200

Confirms that the listed equipment (not included in Annex IV the Machine Directive) complies with the requirements of the directives as well as with Annex II paragraphs 2 and 3 of the Electromagnetic Compatibility Directive, referring only to the Technical File supplied to LGAI Technological Center, S.A. for its evaluation.

The CE mark as shown below can be used, under the responsibility of the manufacturer, after completion of an EC Declaration of Conformity and compliance with all relevant EC Directive

Bellaterra, 02th March, 2020



Applus⁺
 LGAI Technological Center, S.A.
 Xavier Ruiz Peña
 Managing Director, Product Conformity B.U.

Tekniske data

BRHR-325 V - 325/400 m³

Overensstemmelseserklæring

EC DECLARATION OF CONFORMITY /
AT UYGUNLUK BEYANI

We here with declare / Biz iş bu beyanname ile

BSK HAVALANDIRMA EKİPMANLARI A.Ş

That the following described device in our delivered version complies with the appropriate basic safety and health requirements of the EC Machinery Directive 2006/42/EC based on its design and type, as brought into circulati on by us. Incase of alteration of the device, not agreed up on by us, this declaration will lose its validity.

Aşağıda bilgileri bulunan, tarafımızdan imal edilip teslim edilen cihaz, 2006/42/EC Makine Emniyet Yönetmeliğine göre tasarlanmıştır. Tarafımızdan cihazda uygun olmayan bir değişiklik yapılması durumunda bu beyanname geçerliliğini yitirecektir.

Firma Ünvanı / Company Name: **BSK HAVALANDIRMA EKİPMANLARI A.Ş**

Adres / Address : **MİMAR SİNAN MAH. BASRA CAD. NO:59 SULTANBEYLİ/İSTANBUL**

Makine Tanımı / Machine: **ISI GERİ KAZANIM CİHAZI / HEAT RECOVERY DEVICE**

Marka / Brand : **BSK HAVALANDIRMA**

Model Adı / Model Name:

1. BRHR-100 V 2. BRHR-150 V 3. BRHR-180 V 4. BRHR-325 V 5. BRHR-400 V 6. BRHR-500 V 7. BRHR-750 V 8. BRHR-1000 V 9. BRHR-1500 V 10. BRHR-2000 V 11. BRHR-2500 V 12. BRHR-3000 V 13. BRHR-3500 V 14. BRHR-4000 V 15. BRHR-4500 V 16. BRHR-5000 V 17. BRHR 100 S 18. BRHR 150 S 19. BRHR 180 S 20. BRHR 325 S 21. BRHR 400 S 22. BRHR-500 S 23. BRHR-750 S 24. BRHR-1000 S 25. BRHR-1500 S 26. BRHR-2000 S 27. BRHR-2500 S 28. BRHR-3000 S 29. BRHR-3500 S 30. BRHR-4000 S 31. BRHR-4500 S 32. BRHR-5000 S 33. BRHR-100 H 34. BRHR-150 H 35. BRHR-180 H 36. BRHR-325 H 37. BRHR-400 H 38. BRHR-500 H 39. BRHR-750 H 40. BRHR-1000 H 41. BRHR -1500 H 42. BRHR-2000 H 43. BRHR-2500 H 44. BRHR-3000 H 45. BRHR-3500 H 46. BRHR-4000 H 47. BRHR-4500 H 48. BRHR-5000 H 49. BRHR-150 SLIM 50. VENTI 100 51. VENTI 150 52. VENTI 200 53. VENTI 300 54. VENTI 400 55. VENTI 500 56. BRHR 220 S 57. BRHR 220 H 58. BRHR 220 H 59. BRHR PLUS 500 S 60. BRHR PLUS 500 V 61. BRHR PLUS500 H 62. BRHR PLUS 1000 S 63. BRHR PLUS 1000 H 64. BRHR PLUS 1000 H 65. BRHR PLUS 1500 S 66. BRHR PLUS 1500 V 67. BRHR PLUS 1500 H 68. BRHR PLUS 2000 S 69. BRHR PLUS 2000 V 70. BRHR PLUS 2000 H 71. BRHR PLUS 2500 S 72. BRHR PLUS 2500 V 73. BRHR PLUS 2500 H 74. BRHR PLUS 3000 S 75. BRHR PLUS 3000 V 76. BRHR PLUS 3000 H 77. BRHR PLUS 4000 S 78. BRHR PLUS 4000 V 79. BRHR PLUS 4000 H

Applicable Harmonized Standards / Uygulanan Standartlar: -2006/42/EC Machinery Safety Directive

Authorized Name Surname/Job Title/Görevi - Date/Tarih – Authorized Signature/Yetkili İmzası

General Manager / Genel Müdür

20.02.2020

TURAN OKAR

BSK HAVALANDIRMA EKİPMANLARI A.Ş.
M. Sinan Mah. Basra Cad. No:59/1A Sultanbeyli / İS...
Tel.: 0216 669 09 70 (pbx) Fax: 669 09 77

Address/Adresi: **Mimar Sinan Mah. Basra Cad. No:59 Sultanbeyli/İSTANBUL**

Phone / Telefon: : +90 216 669 09 70-71

Fax / Faks: -

Mail: info@bskhavalandirma.com.tr

Web : www.bskhavalandirma.com.tr

DECLARATION OF CONFORMITY